

PRODUCT CATALOG

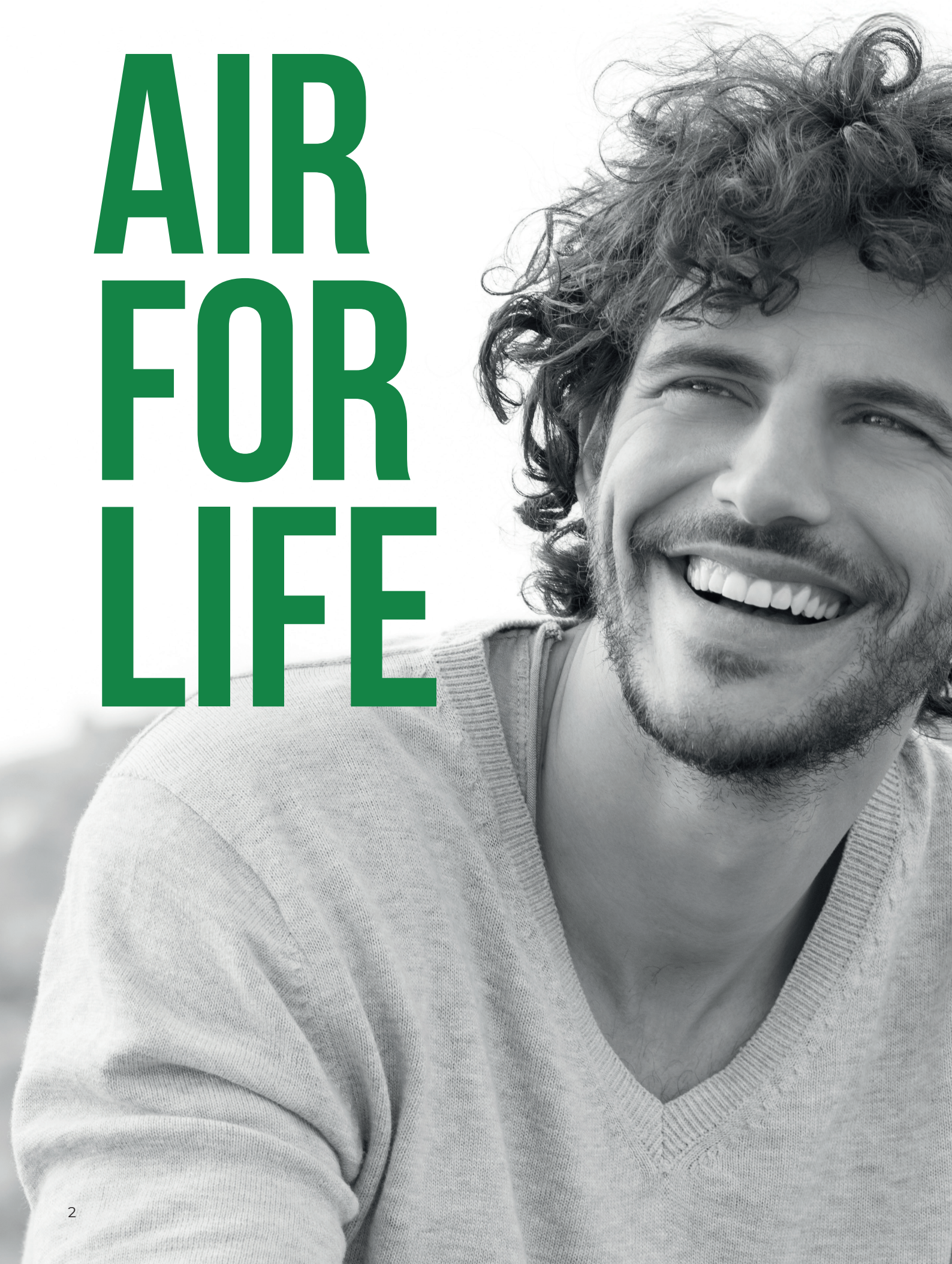

AIR FOR LIFE



APPLICATIONS

● since 1992



AIR FOR DENTISTRY

Compressed air and vacuum for a wide range of dental equipment and devices in dental surgeries and clinics. From compressors to suction systems.



AIR FOR LABORATORIES

High quality compressed air for various diagnostic, analytical and measurement devices to drive and control their pneumatic components.



AIR FOR HEALTHCARE

Quiet and reliable compressors for respiratory equipment (lung ventilators and anesthesia machines), for surgical instruments and sterilisation.



AIR FOR INDUSTRY

Oil-free compressors and air pumps for transportation, food, textile industry and railways. Options for on-demand product customization.





DENTAL COMPRESSORS

AIR FOR SMILE

COMPRESSORS



DK50 SIMPLE

	0.58 HP
	65 psi
	1 gal
	1.8 cfm
S1-S3	S1 - 100%
+	BOX



DK50-10

	0.74 HP
	87 psi, 116 psi
	2.2 gal
	2.47 cfm
S1-S3	S1 - 100%
+	BOX MD AD FS REG AOK



DK50 PLUS

	0.74 HP
	87 psi, 116 psi
	5.5 gal
	2.47 cfm
S1-S3	S1 - 100%
+	BOX MD AD FS REG AOK



DK50 2V

	1.6 HP
	87 psi, 116 psi
	5.5 gal
	4.77 cfm
S1-S3	S1 - 100%
+	BOX MD AD FS REG AOK



For full range of our product portfolio visit www.ekom.sk

COMPRESSORS



DK50 2V/50

	1.6 HP
	87 psi, 116 psi
	11 gal
	4.77 cfm
S1-S3	S1 - 100%
+	BOX MD AD FS REG AOK 3KOM



DK50 4VR/50

	3 HP
	87 psi, 116 psi
	11 gal
	9.54 cfm
S1-S3	S1 - 100%
+	BOX MD AD FS REG AOK 3KOM



DK50 2X2V/110

	2 x 1.6 HP
	87 psi, 116 psi
	24.2 gal
	9.54 cfm
S1-S3	S1 - 100%
+	BOX MD AD FS REG AOK 3KOM



DK50 2X4VR/110

	2 x 3 HP
	87 psi, 116 psi
	24.2 gal
	19 cfm
S1-S3	S1 - 100%
+	BOX MD AD FS REG AOK 3KOM



NOISE REDUCTION CABINETS

BOX Designed for quiet working environments in surgeries, labs or industrial spaces where compressors are used frequently. Sheet metal cabinets with sound-proofing foams minimize the noise by 20 dB(A). They feature active ventilation to ensure effective airflow and control heat management of compressor.

DRYERS

MD

Membrane dryers for applications which require standard dry air at pressure dew point +3°C, ensuring optimal performance of dental, laboratory or other equipment.

AD

Adsorption dryers with pressure dew points -20°C, -40°C and even -70°C provide very dry compressed air for the most demanding applications.

RD

Refrigerating dryers with pressure dew point of +3°C are designed for any equipment and application where high flows and standard dry air is required.



COMPRESSORS WITH DENTAL SUCTION SYSTEM



DUO

	0.74 HP
	87 psi
	5.5 gal
	2.47 cfm
	38.85 cfm
	1.74 psi
S1-S3	S1 - 100 %
+	BOX MD FS REG AOK DS

DUO 2V

	1.48 HP
	87 psi
	5.5 gal
	4.77 cfm
	38.85 cfm
	1.74 psi
S1-S3	S1 - 100 %
+	BOX MD FS REG AOK DS

DUO 2

	1.48 HP
	87 psi
	5.5 gal
	4.77 cfm
	2 x 38.88 cfm
	1.74 psi
S1-S3	S1 - 100 %
+	BOX MD FS REG AOK DS



DBXe

	0.49 HP
	72.6 psi
	1.8 gal
	1.77 cfm
	10.6 cfm
	1.9 psi
S1-S3	S1 - 100 %
+	BOX DS



DBX-De

	0.49 HP
	72.6 psi
	1.8 gal
	1.77 cfm
	38.8 cfm
	1.74 psi
S1-S3	S1 - 100 %
+	BOX DS



For full range of our product portfolio visit www.ekom.sk

DENTAL SUCTION SYSTEMS



WET SUCTION

DO 3 / BASIC

	10.6 cfm
	1.9 psi
S1-S3	S1 - 100 %
+	BOX DS VV HF

DO 3 / STANDARD

	21.2 cfm
	2.3 psi
S1-S3	S1 - 100 %
+	BOX DS AS VV HF

DO 3 / ADVANCED

	31.8 cfm
	2.9 psi
S1-S3	S1 - 100 %
+	BOX DS AS VV HF

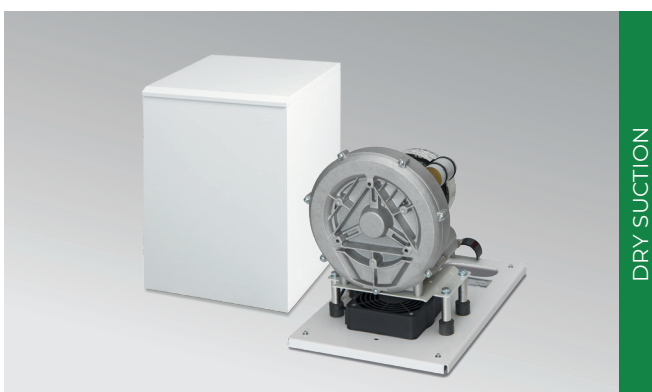

DRY SUCTION

DO 2.1

	38.8 cfm
	1.74 psi
S1-S3	S1 - 100 %
+	BOX DS



WET SUCTION

DO M

	38.8 cfm
	1.74 psi
S1-S3	S1 - 100 %
+	BOX



For full range of our product portfolio visit www.ekom.sk

A black and white photograph of a man with a beard and long hair, wearing a striped shirt, blowing bubbles on a beach. He is holding a bubble wand and a small bottle of bubble solution. The background is a bright, hazy beach scene. A purple circle is positioned above the text 'LABORATORY COMPRESSORS'.

LABORATORY COMPRESSORS

AIR FOR SCIENCE

MOBILE COMPRESSORS



DK50-10 S/M MOBILE

 0.73 HP

 _{OUT} 94 psi

 2.2 gal

 1.77 cfm

S1-S3 S1 - 100%

+ BOX MD FS REG



DK50 2V MOBILE

 1.6 HP

 _{OUT} 87 psi, 116 psi

 5.5 gal

 14.8 cfm

S1-S3 S1 - 100%

+ BOX MD FS REG



For full range
of our product
portfolio visit
www.ekom.sk

COMPRESSOR STATIONS



DK50 3X4VR/M

	3 x 2.95 HP
	87 psi, 116 psi
	63.8 gal
	27.54 cfm
S1-S3	S1 - 100 %
+	RD AD FS REG



DK50 4X4VRT/M

	4 x 2.95 HP
	87 psi, 116 psi
	110 gal
	36.73 cfm
S1-S3	S1 - 100 %
+	BOX RD AD FS REG CI



DK50 6X4VRT/M

	6 x 2.95 HP
	87 psi, 116 psi
	110 gal
	55 cfm
S1-S3	S1 - 100 %
+	BOX RD AD FS REG CI



DK50 9X4VRT/M

	9 x 2.95 HP
	87 psi, 116 psi
	110 gal
	184 cfm
S1-S3	S1 - 100 %
+	BOX RD AD FS REG CI







For full range of our product portfolio visit www.ekom.sk



DK 355 SC/M

Scroll compressor with 500-liter air tank provides a reliable and efficient air supply for various applications. Supplied with either an adsorption or refrigeration dryer, the compressor is housed in a noise reduction cabinet. Touch-screen display offers real-time monitoring of pressure, temperature and humidity, enabling operators to easily manage the system's performance and adjust settings as needed.

DK 355 SC/M

	3 x 7.4 HP
 OUT	87 psi
	110 gal
	56.2 cfm
S1-S3	S1 - 100 %
+	BOX AD FS REG

AIR TREATMENT UNITS

All-in-one systems that feature an efficient cooler, water separator, two-chamber adsorption dryer and air outlet filtration. Suitable for air flows from 17.7 cfm to 79.5 cfm at pressures up to 130.5 psi and pressure dew points -20°C, -40°C and even -70°C. An optional dew point sensor can be included for providing precise monitoring of humidity. Designed to be placed at the air end of any oil-free compressor.



	AD500	AD1500	AD2250
 OUT	87 psi, 116 psi	87 psi, 116 psi	87 psi, 116 psi
	17.7 cfm	53 cfm	79.5 cfm
S1-S3	S1 - 100 %	S1 - 100 %	S1 - 100 %



INDUSTRIAL COMPRESSORS



AIR FOR MOTION



COMPRESSOR PUMPS

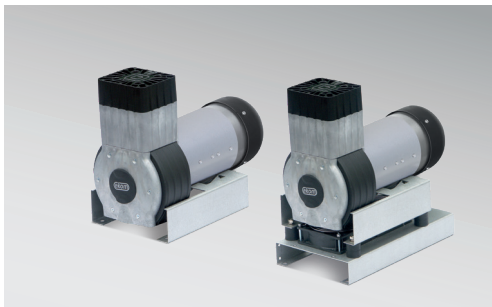

FOR DIRECT CURRENT (DC)



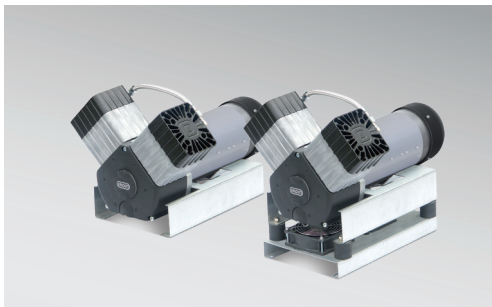

DJ / DJX

 0.8 HP
 (max) 116 psi
 2.1 cfm / 102 psi
S1-S3 S1 - 100%





DV / DVX

 1.5 HP
 (max) 116 psi
 3.9 cfm / 102 psi
S1-S3 S1 - 100%

FOR ALTERNATING CURRENT (AC)





AJ / AJX

 0.74 HP
 (max) 116 psi
 2.65 cfm / 72.5 psi
S1-S3 S1 - 100%



AV / AVX

 1.6 HP
 (max) 116 psi, 145 psi
 4.9 cfm / 72.5 psi
S1-S3 S1 - 100%



For full range
of our product
portfolio visit
www.ekom.sk



MEDICAL COMPRESSORS



AIR FOR HEALTH

MEDICAL COMPRESSORS



DK50 DI

	50.76 psi
	1.94 cfm
Peak flow	6.4 cfm / 0.5 s
	0.01 µm
S1-S3	S1 - 100 %
+	BOX MD FS



DK50 DS / BASIC / STANDARD / ADVANCED

	50.76 psi
	1.4 / 1.8 / 2.1 cfm
Peak flow	7 cfm / 0.5 s
	5 µm
S1-S3	S1 - 100 %
+	BOX MD FS SD30



DK50 DE / BASIC / STANDARD / ADVANCED

	50.76 psi
	1.4 / 1.8 / 2.1 cfm
Peak flow	7 cfm / 0.5 s
	5 µm
S1-S3	S1 - 100 %
+	BOX MD FS SD30



DK50 DE LOW FLOW

	43.5 psi
	0.7 cfm
Peak flow	N/A
	5 µm
S1-S3	S1 - 100 %
+	BOX



For full range of our product portfolio visit www.ekom.sk

ACCESSORIES



BOX NOISE REDUCTION CABINETS

Sheet metal cabinets with active cooling and effective noise reduction up to 20 dB(A).



AD ADSORPTION DRYER

Compact all-in-one dryers with pressure dew points -20°C , -40°C and -70°C for ultra dry air requirements.



MD MEMBRANE DRYER

Quiet dryers with coolers for small compressors with pressure dew point 3°C and $0.1\mu\text{m}$ filtration.



RD REFRIGERATION DRYER

Condensation dryer units with pressure dew point $+3^{\circ}\text{C}$ for high flow applications.



FS FILTRATION UNITS

Modular filters for flows from $50 \text{ l}\cdot\text{min}^{-1}$ to $2500 \text{ l}\cdot\text{min}^{-1}$, with filtration down to $0.01\mu\text{m}$, optionally with AC / HC filters.



AOK AUTOMATIC DISCHARGE OF CONDENSATE

Kit to automatically discharge condensate from compressor air tank at user-adjusted time intervals.



REG PRESSURE REGULATORS

Adjustable pressure regulators ranging from 0.5 to 8.5 bar, with interface available from $1/4''$ to $3/4''$.

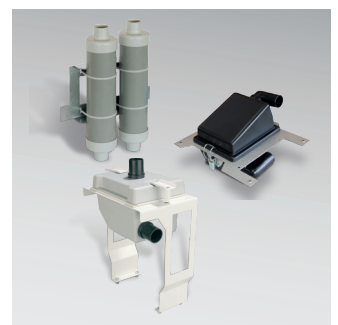

DS EXHAUST SILENCER

Suitable for suction units to minimize the noise at air exhaust by 4 dB(A). Options with HEPA filter and standard filtration.



3KOM **3KOM CONTROL SYSTEM**

Two or three EKOM compressors connected in stand-by / duty. The system controls the gradual startup and function rotation.



AS **AMALGAM SEPARATOR KIT**

Mounting frame kit for DO 3 Standard and Advance to use with standard sedimentation amalgam separators (not included).



VV **VACUUM VALVE**

A control of the vacuum pressure in dental suction system, ensuring optimal performance and cooling of the suction blower.



HF **SILENCER WITH HEPA FILTER**

Optional for all types of DO 3 for noise reduction and enhancing the hygiene and comfort of the clinical environment.



CI **CENTRAL INTAKE FILTER**

A central filter kit, reducing all air pump intake filters into one large filter with a mount. Designed for all TOWER compressors.



SD30 **MOBILE TROLLEY SD30**

Designed for DK50 DS and DE for mounting respiratory ventilator. Braked castors. Optional humidifier holder. Customizable mounting plate.



For full range of our product portfolio visit www.ekom.sk

EKOM



EKOM spol. s r.o., Priemyselná 5031/18, 921 01 PIEŠŤANY, Slovak Republic, www.ekom.sk

The company reserves the right to change the technical data of the products without prior notice. The content of this catalog is subject to the copyright of EKOM and its modification or reproduction without permission is unauthorized.